

The Garador Range Spares Catalogue

Up & Over Doors, Sectional Doors, Side-hinged Doors and Operators



March 2011

GARADOR
The Garage Door People

Contents

C Type Overhead Spring Box fitted to a timber frame	4
C Type Side Extension Spring fitted to a timber frame	8
F Type & MK 4 Spring	10
R, FR & DR Spring	12
DC Type Spring	14
Cables, Rollers, Spindles	16
Keys, Locking Barrels.	17
Handle Mechanisms	18
Weatherseals	19
Latches	20
C & F Type Accessories	21
Link Arms	22
DR, R, FR & DC Type Accessories	23
Springs	24
Spares for current range of electric operators	26
Radio Receivers, Transmitters, Autodor Spares.	27
Consumables	28
Care	29
Warranty	30
Extracts from DHF consumer advice	31

Please ensure that you order the correct size door to fit your opening as we are unable to accept the return of incorrectly ordered goods. Please contact Garador on 01935 443722 if you need assistance in calculating the correct size.





A comprehensive range of the more popular spares is available. Please ask for spares price list.



All prices in £.

Note: All orders for spares carry a postage and package cost of £6.50 per order regardless of the quantity or value.

Since the company's policy is one of continuous improvement of its products, we reserve the right to make any alterations in design, manufacture or price. All business is governed by the Company's Standard Conditions and this document does not form any part of any contract with the company and statements contained in it should not be construed as representations or warranties.

Used on all Canopy doors pre 1999. Springs priced and supplied individually. However, it is always recommended that both springs are replaced at the same time.

 £ 57.00 ea.	 GEORGIAN/GEORGIAN ELITE			 CARLTON/CARLTON ELITE			 SALISBURY/SALISBURY ELITE		
	Spring box number	Spring box spring	No. of bands & colour	Spring box number	Spring box spring	No. of bands & colour	Spring box number	Spring box spring	No. of bands & colour
6'6"x6'3"	-	-	-	PN58	4739	1 x Silver	-	-	-
6'6"x6'6"	PN167	4743	None	PN58	4739	1 x Silver	-	-	-
6'6"x7'0"	PN167	4743	None	PN58	4739	1 x Silver	-	-	-
7'0"x6'3"	-	-	-	N/A	N/A	N/A	-	-	-
7'0"x6'6"	PN57/1	4740	1 x Blue	PN58	4739	1 x Silver	PN55/2	4742	3 x Blue
7'0"x7'0"	PN150	4746	None	PN55/2	4742	3 x Blue	PN155	4747	1 x Orange
7'3½"x6'4"	-	-	-	PN57/1	4740	1 x Blue	-	-	-
7'5"x6'3"	-	-	-	-	-	-	-	-	-
7'5"x6'6"	PN55/2	4742	3 x Blue	PN57/1	4740	1 x Blue	PN155	4747	1 x Orange
7'5"x7'0"	PN108	4745	2 x Orange	PN150	4746	None	PN108	4745	2 x Orange
7'6"x6'6"	PN55/2	4742	3 x Blue	PN57/1	4740	1 x Blue	PN155	4747	1 x Orange
7'6"x7'0"	N/A	N/A	N/A	N/A	N/A	N/A	N/A	N/A	N/A
7'8½"x6'3"	-	-	-	N/A	N/A	N/A	-	-	-
7'8½"x6'6¾"	PN150	4746	None	PN55/2	4742	3 x Blue	-	-	-
7'8½"x6'11¼"	N/A	N/A	N/A	PN155	4747	1 x Orange	-	-	-
8'0"x6'3"	-	-	-	N/A	N/A	N/A	-	-	-
8'0"x6'6"	PN150	4746	None	PN55/2	4742	3 x Blue	PN150	4746	None
8'0"x7'0"	PN108	4745	2 x Orange	PN155	4747	1 x Orange	PN155	4747	1 x Orange
8'2½"x6'3"	-	-	-	N/A	N/A	N/A	-	-	-
8'2½"x6'6¾"	-	-	-	PN150	4746	None	-	-	-
8'2½"x6'11¼"	-	-	-	PN155	4747	1 x Orange	-	-	-

	 HORIZON/HORIZON ELITE			 CHEVRON/CHEVRON ELITE			 BEAUMONT/BEAUMONT ELITE		
	Spring box number	Spring box spring	No. of bands & colour	Spring box number	Spring box spring	No. of bands & colour	Spring box number	Spring box spring	No. of bands & colour
6'6"x6'3"	PN58	4739	1 x Silver	-	-	-	-	-	-
6'6"x6'6"	PN58	4739	1 x Silver	PN167	4743	None	-	-	-
6'6"x7'0"	PN58	4739	1 x Silver	PN167	4743	None	-	-	-
7'0"x6'3"	N/A	N/A	N/A	-	-	-	-	-	-
7'0"x6'6"	PN58	4739	1 x Silver	PN57/1	4740	1 x Blue	4742	3 x Blue	
7'0"x7'0"	PN57/1	4740	1 x Blue	PN55/2	4742	3 x Blue	4747	1 x Orange	
7'3½"x6'4"	PN56/1	4741	2 x Blue	-	-	-	-	-	-
7'5"x6'3"	N/A	N/A	N/A	-	-	-	-	-	-
7'5"x6'6"	PN56/1	4741	2 x Blue	PN55/2	4742	3 x Blue	4742	3 x Blue	
7'5"x7'0"	PN55/2	4742	3 x Blue	PN155	4747	1 x Orange	-	-	-
7'6"x6'6"	PN57/1	4740	1 x Blue	PN55/2	4742	3 x Blue	-	-	-
7'6"x7'0"	N/A	N/A	N/A	N/A	N/A	N/A	4747	1 x Orange	
7'8½"x6'3"	N/A	N/A	N/A	-	-	-	-	-	-
7'8½"x6'6¾"	PN115	4744	2 x Silver	PN55/2	4742	3 x Blue	-	-	-
7'8½"x6'11¼"	PN55/2	4742	3 x Blue	PN155	4747	1 x Orange	-	-	-
8'0"x6'3"	N/A	N/A	N/A	-	-	-	-	-	-
8'0"x6'6"	PN115	4744	2 x Silver	-	-	-	-	-	-
8'0"x7'0"	PN150	4746	None	-	-	-	-	-	-
8'2½"x6'3"	N/A	N/A	N/A	-	-	-	-	-	-
8'2½"x6'6¾"	PN55/2	4742	3 x Blue	-	-	-	-	-	-
8'2½"x6'11¼"	PN155	4747	1 x Orange	-	-	-	-	-	-



£ 57.00 ea.







CATHEDRAL/CATHEDRAL ELITE









PARADE-WHITE/BROWN

	CATHEDRAL/CATHEDRAL ELITE			PARADE-WHITE/BROWN		
	Spring box number	Spring box spring	No.of bands & colour	Spring box number	Spring box spring	No.of bands & colour
6'6"x6'3"	-	-	-	-	-	-
6'6"x6'6"	-	-	-	PN167	4743	None
6'6"x7'0"	-	-	-	-	-	-
7'0"x6'3"	-	-	-	-	-	-
7'0"x6'6"	PN55/2	4742	3 x Blue	PN57/1	4740	1 x Blue
7'0"x7'0"	PN155	4747	1 x Orange	PN155	4747	1 x Orange
7'3½"x6'4"	-	-	-	-	-	-
7'5"x6'3"	-	-	-	-	-	-
7'5"x6'6"	PN55/2	4742	3 x Blue	PN155	4747	1 x Orange
7'5"x7'0"	-	-	-	PN155	4747	1 x Orange
7'6"x6'6"	-	-	-	N/A	N/A	N/A
7'6"x7'0"	PN155	4747	1 x Orange	N/A	N/A	N/A
7'8½"x6'3"	-	-	-	-	-	-
7'8½"x6'6¾"	-	-	-	-	-	-
7'8½"x6'11¼"	-	-	-	-	-	-
8'0"x6'3"	-	-	-	-	-	-
8'0"x6'6"	-	-	-	PN155	4747	1 x Orange
8'0"x7'0"	-	-	-	PN108	4745	2 x Orange
8'2½"x6'3"	-	-	-	-	-	-
8'2½"x6'6¾"	-	-	-	-	-	-
8'2½"x6'11¼"	-	-	-	-	-	-

Used on all Canopy doors pre 1999. Springs priced and supplied individually. However, it is always recommended that both springs are replaced at the same time.

 <p>£ 57.00 ea.</p>	 STAMFORD			 ARDEN			 KENMORE			
	Spring box number	Spring box spring	No. of bands & colour	Spring box number	Spring box spring	No. of bands & colour	Spring box number	Spring box spring	No. of bands & colour	
	7'0"x6'6"	N/A	N/A	N/A	PN55/2	4742	3 x Blue	PN55/2	4742	3 x Blue
	7'0"x7'0"	N/A	N/A	N/A	PN55/2	4742	3 x Blue	PN55/2	4742	3 x Blue
	7'5"x6'6"	N/A	N/A	N/A	PN155	4747	1 x Orange	PN155	4747	1 x Orange
7'6"x7'0"	N/A	N/A	N/A	PN155	4747	1 x Orange	PN155	4747	1 x Orange	

 DERWENT			 SWINTON			 CLIFTON			
Spring box number	Spring box spring	No. of bands & colour	Spring box number	Spring box spring	No. of bands & colour	Spring box number	Spring box spring	No. of bands & colour	
7'0"x6'6"	N/A	N/A	N/A	PN55/2	4742	3 x Blue	PN55/2	4742	3 x Blue
7'0"x7'0"	N/A	N/A	N/A	PN55/2	4742	3 x Blue	PN55/2	4742	3 x Blue
7'5"x6'6"	N/A	N/A	N/A	PN155	4747	1 x Orange	PN155	4747	1 x Orange
7'6"x7'0"	N/A	N/A	N/A	PN155	4747	1 x Orange	PN155	4747	1 x Orange





 OAKHAM			 WOBURN			 WENTWOOD			
Spring box number	Spring box spring	No. of bands & colour	Spring box number	Spring box spring	No. of bands & colour	Spring box number	Spring box spring	No. of bands & colour	
7'0"x6'6"	PN55/2	4742	3 x Blue	N/A	N/A	N/A	PN55/2	4742	3 x Blue
7'0"x7'0"	PN55/2	4742	3 x Blue	N/A	N/A	N/A	PN155	4747	1 x Orange
7'5"x6'6"	PN155	4747	1 x Orange	N/A	N/A	N/A	PN55/2	4742	3 x Blue
7'6"x7'0"	PN155	4747	1 x Orange	N/A	N/A	N/A	PN155	4747	1 x Orange



 SHERWOOD			
Spring box number	Spring box spring	No. of bands & colour	
7'0"x6'6"	PN55/2	4742	3 x Blue
7'0"x7'0"	PN155	4747	1 x Orange
7'5"x6'6"	PN55/2	4742	3 x Blue
7'6"x7'0"	PN155	4747	1 x Orange



C Type Overhead Spring Box fitted to a timber frame

Timber Panel Doors

Used on all Canopy doors pre 1999. Springs priced and supplied individually. However, it is always recommended that both springs are replaced at the same time.

 <p>£ 57.00 ea.</p>	 <p>CHEVRON CEDAR</p>			 <p>VERTICAL CEDAR</p>			 <p>SANDHURST</p>			
	Spring box number	Spring box spring	No. of bands & colour	Spring box number	Spring box spring	No. of bands & colour	Spring box number	Spring box spring	No. of bands & colour	
	7'0"x6'6"	PN57/1	4740	1 x Blue	PN57/1	4740	1 x Blue	-	-	-
	7'0"x7'0"	PN55/2	4742	3 x Blue	PN55/2	4742	3 x Blue	PN55/2	4742	3 x Blue
	7'5"x6'6"	PN55/2	4742	3 x Blue	PN57/1	4740	1 x Blue	PN55/2	4742	3 x Blue
	7'5"x7'0"	PN55/2	4742	3 x Blue	PN150	4746	None	PN55/2	4742	3 x Blue
	7'6"x6'6"	PN55/2	4742	3 x Blue	PN55/2	4742	3 x Blue	PN55/2	4742	3 x Blue
7'6"x7'0"	-	-	-	PN55/2	4742	3 x Blue	-	-	-	





 <p>CAVENDISH</p>			 <p>WOLSEY</p>			 <p>SEYMOUR</p>		
Spring box number	Spring box spring	No. of bands & colour	Spring box number	Spring box spring	No. of bands & colour	Spring box number	Spring box spring	No. of bands & colour
7'0"x6'6"	-	-	PN55/2	4742	3 x Blue	PN55/2	4742	3 x Blue
7'0"x7'0"	PN55/2	4742	PN155	4747	1 x Orange	PN155	4747	1 x Orange
7'5"x6'6"	PN55/2	4742	PN55/2	4742	3 x Blue	PN55/2	4742	3 x Blue
7'5"x7'0"	PN55/2	4742	PN155	4747	1 x Orange	PN155	4747	1 x Orange
7'6"x6'6"	PN55/2	4742	PN55/2	4742	3 x Blue	PN55/2	4742	3 x Blue
7'6"x7'0"	-	-	PN55/2	4742	3 x Blue	PN55/2	4742	3 x Blue





 <p>TUDOR</p>			 <p>HORIZONTAL CEDAR</p>		
Spring box number	Spring box spring	No. of bands & colour	Spring box number	Spring box spring	No. of bands & colour
7'0"x6'6"	PN55/2	4742	PN57/1	4740	1 x Blue
7'0"x7'0"	PN155	4747	PN55/2	4742	3 x Blue
7'5"x6'6"	PN55/2	4742	PN57/1	4740	1 x Blue
7'5"x7'0"	PN155	4747	PN150	4746	None
7'6"x6'6"	PN55/2	4742	-	-	-
7'6"x7'0"	PN55/2	4742	-	-	-

C Type Side Extension Spring fitted to a timber frame

Steel Panel Doors

Used on all Canopy doors between 1999 and 2002. Springs priced and supplied individually. However, it is always recommended that both springs are replaced at the same time.



 £ 57.00 ea.	 GEORGIAN/ GEORGIAN ELITE		 BEAUMONT/ BEAUMONT ELITE		 CATHEDRAL/ CATHEDRAL ELITE		 CARLTON/ CARLTON ELITE	
	Spring type	No. of bands & colour	Spring type	No. of bands & colour	Spring type	No. of bands & colour	Spring type	No. of bands & colour
6'6"x6'3"	-	-	-	-	-	-	4733	White
6'6"x6'6"	4735	Green	-	-	-	-	4733	White
6'6"x7'0"	4737	Red	-	-	-	-	4734	2 x White
7'0"x6'3"	-	-	-	-	-	-	4733	White
7'0"x6'6"	4735	Green	4735	Green	4735	Green	4733	White
7'0"x7'0"	4737	Red	4736	2 x Green	4736	2 x Green	4734	2 x White
7'3½"x6'4"	-	-	-	-	-	-	4734	2 x White
7'5"x6'3"	-	-	-	-	-	-	4734	2 x White
7'5"x6'6"	4736	2 x Green	4735	Green	4735	Green	4734	2 x White
7'5"x7'0"	4737	Red	4737	Red	4737	Red	4735	Green
7'6"x6'6"	4736	2 x Green	4736	2 x Green	4736	2 x Green	4735	Green
7'6"x7'0"	4737	Red	4737	Red	4737	Red	4736	2 x Green
7'8½"x6'3"	-	-	-	-	-	-	4733	White
7'8½"x6'6¾"	4736	2 x Green	4736	2 x Green	4736	2 x Green	4734	2 x White
7'8½"x6'11¼"	4737	Red	4736	2 x Green	4736	2 x Green	4735	Green
8'0"x6'3"	-	-	-	-	-	-	4735	Green
8'0"x6'6"	4738	2 x Red	4736	2 x Green	4736	2 x Green	4736	2 x Green
8'0"x7'0"	4738	2 x Red	4737	Red	4737	Red	4736	2 x Green
8'2½"x6'3"	-	-	-	-	-	-	4735	Green
8'2½"x6'6¾"	-	-	-	-	-	-	4736	2 x Green
8'2½"x6'11¼"	-	-	-	-	-	-	4736	2 x Green





	 SALISBURY/ SALISBURY ELITE		 HORIZON/ HORIZON ELITE		 CHEVRON/ CHEVRON ELITE		 PARADE-WHITE/BROWN	
	Spring type	No. of bands & colour	Spring type	No. of bands & colour	Spring type	No. of bands & colour	Spring type	No. of bands & colour
6'6"x6'3"	-	-	4733	White	-	-	-	-
6'6"x6'6"	-	-	4733	White	4733	White	-	-
6'6"x7'0"	-	-	4734	2 x White	4734	2 x White	-	-
7'0"x6'3"	-	-	4733	White	-	-	-	-
7'0"x6'6"	4735	Green	4733	White	4734	2 x White	4735	Green
7'0"x7'0"	4737	Red	4734	2 x White	4734	2 x White	4736	2 x Green
7'3½"x6'4"	-	-	4733	White	-	-	-	-
7'5"x6'3"	-	-	4733	White	-	-	-	-
7'5"x6'6"	4737	Red	4733	White	4735	Green	4735	Green
7'5"x7'0"	4737	Red	4734	2 x White	4738	2 x Red	4737	Red
7'6"x6'6"	4737	Red	4735	Green	4736	2 x Green	4736	2 x Green
7'6"x7'0"	4737	Red	4735	Green	4738	2 x Red	4737	Red
7'8½"x6'3"	-	-	4733	White	-	-	-	-
7'8½"x6'6¾"	-	-	4734	2 x White	4736	2 x Green	4736	2 x Green
7'8½"x6'11¼"	-	-	4735	Green	4738	2 x Red	4736	2 x Green
8'0"x6'3"	-	-	4735	Green	-	-	-	-
8'0"x6'6"	4737	Red	4735	Green	-	-	4736	2 x Green
8'0"x7'0"	4738	2 x Red	4735	Green	-	-	4737	Red
8'2½"x6'3"	-	-	4735	Green	-	-	-	-
8'2½"x6'6¾"	-	-	4735	Green	-	-	-	-
8'2½"x6'11¼"	-	-	4736	2 x Green	-	-	-	-

C Type Side Extension Spring fitted to a timber frame

GRP Premier Panel Doors

Used on all Canopy doors between 1999 and 2002. Springs priced and supplied individually. However, it is always recommended that both springs are replaced at the same time.





 <p>£ 57.00 ea.</p>	 STAMFORD		 ARDEN		 KENMORE		 DERWENT	
	Spring type	No. of bands & colour	Spring type	No. of bands & colour	Spring type	No. of bands & colour	Spring type	No. of bands & colour
	7'0"x6'6"	4734 2 x White	4734 2 x White	4734 2 x White	4734 2 x White	4734 2 x White	4734 2 x White	4734 2 x White
	7'0"x7'0"	4735 Green	4735 Green	4735 Green	4735 Green	4735 Green	4735 Green	4735 Green
	7'5"x6'6"	4734 2 x White	4734 2 x White	4734 2 x White	4734 2 x White	4734 2 x White	4734 2 x White	4734 2 x White
7'6"x7'0"	4735 Green	4735 Green	4735 Green	4735 Green	4735 Green	4735 Green	4735 Green	





 <p>£ 57.00 ea.</p>	 SWINTON		 CLIFTON		 OAKHAM		 WOBURN	
	Spring type	No. of bands & colour	Spring type	No. of bands & colour	Spring type	No. of bands & colour	Spring type	No. of bands & colour
	7'0"x6'6"	4734 2 x White	4734 2 x White	4734 2 x White	4734 2 x White	4734 2 x White	4734 2 x White	4734 2 x White
	7'0"x7'0"	4735 Green	4735 Green	4735 Green	4735 Green	4735 Green	4735 Green	4735 Green
	7'5"x6'6"	4734 2 x White	4734 2 x White	4734 2 x White	4734 2 x White	4734 2 x White	4734 2 x White	4734 2 x White
7'6"x7'0"	4735 Green	4735 Green	4735 Green	4735 Green	4735 Green	4735 Green	4735 Green	

C Type Side Extension Spring fitted to a timber frame









Timber Panel Doors

Used on all Canopy doors between 1999 and 2002. Springs priced and supplied individually. However, it is always recommended that both springs are replaced at the same time. Due to timber design changes always check the colour bands on the springs before ordering.

 <p>£ 57.00 ea.</p>	 CHEVRON CEDAR		 VERTICAL CEDAR		 SANDHURST		 CAVENDISH	
	Spring type	No. of bands & colour	Spring type	No. of bands & colour	Spring type	No. of bands & colour	Spring type	No. of bands & colour
	7'0"x6'6"	4734 2 x White	4733 White	-	-	-	-	-
	7'0"x7'0"	4735 Green	4734 2 x White	4736 2 x Green	4736 2 x Green	4736 2 x Green	4736 2 x Green	4736 2 x Green
	7'5"x6'6"	4735 Green	4733 White	4735 Green	4735 Green	4735 Green	4735 Green	4735 Green
7'5"x7'0"	4735 Green	4734 2 x White	4736 2 x Green	4736 2 x Green	4736 2 x Green	4736 2 x Green	4736 2 x Green	
7'6"x6'6"	4735 Green	4734 2 x White	4735 Green	4735 Green	4735 Green	4735 Green	4735 Green	
7'6"x7'0"	-	-	4734 2 x White	-	-	-	-	

 <p>£ 57.00 ea.</p>	 WOLSEY		 SEYMOUR		 TUDOR		 HORIZONTAL CEDAR	
	Spring type	No. of bands & colour	Spring type	No. of bands & colour	Spring type	No. of bands & colour	Spring type	No. of bands & colour
	7'0"x6'6"	4735 Green	4735 Green	4735 Green	4735 Green	4735 Green	N/A	N/A
	7'0"x7'0"	4735 Green	4735 Green	4735 Green	4735 Green	4735 Green	N/A	N/A
	7'5"x6'6"	4735 Green	4735 Green	4735 Green	4735 Green	4735 Green	N/A	N/A
7'5"x7'0"	4736 2 x Green	4736 2 x Green	4736 2 x Green	4736 2 x Green	4736 2 x Green	N/A	N/A	
7'6"x6'6"	4735 Green	4735 Green	4735 Green	4735 Green	4735 Green	-	-	
7'6"x7'0"	4736 2 x Green	4736 2 x Green	4736 2 x Green	4736 2 x Green	4736 2 x Green	-	-	









Used on all Framed Canopy doors pre 2002. For springs with flat fixing pins part 54-6 is also required. Springs priced and supplied individually. However, it is always recommended that both springs are replaced at the same time.

 <p>£ 60.00 ea.</p>	 <p>GEORGIAN/ GEORGIAN ELITE</p> <p>Spring type</p>	 <p>BEAUMONT/ BEAUMONT ELITE</p> <p>Spring type</p>	 <p>CATHEDRAL/ CATHEDRAL ELITE</p> <p>Spring type</p>	 <p>CARLTON/ CARLTON ELITE</p> <p>Spring type</p>	 <p>SALISBURY/ SALISBURY ELITE</p> <p>Spring type</p>	 <p>HORIZON/ HORIZON ELITE</p> <p>Spring type</p>	 <p>CHEVRON/ CHEVRON ELITE</p> <p>Spring type</p>	 <p>PARADE- WHITE/BROWN</p> <p>Spring type</p>													
	6'6"x6'3"	6'6"x6'6"	6'6"x7'0"	7'0"x6'3"	7'0"x6'6"	7'0"x7'0"	7'3½"x6'4"	7'5"x6'3"	7'5"x6'6"	7'5"x7'0"	7'6"x6'6"	7'6"x7'0"	7'8½"x6'3"	7'8½"x6'6¾"	7'8½"x6'11¼"	8'0"x6'3"	8'0"x6'6"	8'0"x7'0"	8'2½"x6'3"	8'2½"x6'6¾"	8'2½"x6'11¼"
-	-	-	-	2149	-	2149	-	-	-	-	-	-	-	-	-	-	-	-	-	-	-
2150	-	-	-	2149	-	2149	2149	-	-	-	-	-	-	-	-	-	-	-	-	-	-
2151	-	-	-	2150	-	2150	2150	-	-	-	-	-	-	-	-	-	-	-	-	-	-
-	-	-	-	2149	-	2149	-	-	-	-	-	-	-	-	-	-	-	-	-	-	-
2151	2150	2150	2150	2149	2151	2149	2149	2149	2149	2151	2151	2151	2151	2151	2151	2151	2151	2151	2151	2151	2151
2153	2152	2152	2152	2151	2152	2150	2150	2150	2150	2153	2150	2150	2150	2150	2150	2150	2150	2150	2150	2150	2150
-	-	-	-	2149	-	2149	-	-	-	-	-	-	-	-	-	-	-	-	-	-	-
-	-	-	-	2150	-	2149	-	-	-	-	-	-	-	-	-	-	-	-	-	-	-
2151	2151	2151	2151	2150	2152	2149	2150	2150	2150	2153	2150	2150	2150	2150	2150	2150	2150	2150	2150	2150	2150
2153	2152	2152	2152	2151	2153	2151	2151	2151	2151	2153	2150	2150	2150	2150	2150	2150	2150	2150	2150	2150	2150
2151	2152	2152	2152	2150	2152	2150	2150	2150	2150	2152	2150	2150	2150	2150	2150	2150	2150	2150	2150	2150	2150
2153	2153	2153	2153	2152	2153	2151	2151	2151	2151	2153	2150	2150	2150	2150	2150	2150	2150	2150	2150	2150	2150
-	-	-	-	2150	-	2150	-	-	-	-	-	-	-	-	-	-	-	-	-	-	-
2152	2152	2152	2152	2150	-	2150	2151	-	-	-	-	-	-	-	-	-	-	-	-	-	-
2153	2152	2152	2152	2152	-	2152	2152	2152	2152	2152	2152	2152	2152	2152	2152	2152	2152	2152	2152	2152	2152
-	-	-	-	2151	-	2150	-	-	-	-	-	-	-	-	-	-	-	-	-	-	-
2152	2152	2152	2152	2151	2153	2150	2150	2150	2150	2153	2150	2150	2150	2150	2150	2150	2150	2150	2150	2150	2150
2153	2153	2153	2153	2152	2153	2152	2152	2152	2152	2153	2152	2152	2152	2152	2152	2152	2152	2152	2152	2152	2152
-	-	-	-	2151	-	2150	-	-	-	-	-	-	-	-	-	-	-	-	-	-	-
-	-	-	-	2151	-	2150	-	-	-	-	-	-	-	-	-	-	-	-	-	-	-
-	-	-	-	2152	-	2152	-	-	-	-	-	-	-	-	-	-	-	-	-	-	-

F Type & MK 4 Spring

GRP Premier Panel Doors









Used on all Framed Canopy doors pre 2002. For springs with flat fixing pins part S4-6 is also required. Springs priced and supplied individually. However, it is always recommended that both springs are replaced at the same time.

 <p>£ 60.00 ea.</p>	 STAMFORD Spring type	 ARDEN Spring type	 KENMORE Spring type	 DERWENT Spring type	 SWINTON Spring type	 CLIFTON Spring type	 OAKHAM Spring type	 WOBURN Spring type
	7'0"x6'6"	2151	2151	2151	2151	2151	2151	2151
7'0"x7'0"	2152	2152	2152	2152	2152	2152	2152	2152
7'5"x6'6"	2152	2152	2152	2152	2152	2152	2152	2152
7'6"x7'0"	2152	2152	2152	2152	2152	2152	2152	2152









F Type & MK 4 Spring

Timber Panel Doors

Used on all Framed Canopy doors pre 2002. For springs with flat fixing pins part S4-6 is also required. Springs priced and supplied individually. However, it is always recommended that both springs are replaced at the same time.

 <p>£ 60.00 ea.</p>	 CHEVRON CEDAR Spring type	 VERTICAL CEDAR Spring type	 SANDHURST Spring type	 CAVENDISH Spring type	 WOLSEY Spring type	 SEYMOUR Spring type	 TUDOR Spring type	 HORIZONTAL CEDAR Spring type
	7'0"x6'6"	2150	2149	2151	2151	2150	2150	2150
7'0"x7'0"	2150	2150	2152	2152	2151	2151	2151	N/A
7'5"x6'6"	2150	2150	2151	2151	2151	2151	2151	N/A
7'5"x7'0"	2151	2150	2152	2152	2152	2152	2152	N/A
7'6"x6'6"	2150	2150	-	-	2151	2151	2151	-
7'6"x7'0"	2151	2150	-	-	2152	2152	2152	-

Used on all FR and R type doors pre 2002 (595 mm long). Springs priced and supplied individually. However, it is always recommended that both springs are replaced at the same time.









 <p>£ 62.00 ea.</p>	 <p>GEORGIAN/ GEORGIAN ELITE</p>	 <p>BEAUMONT/ BEAUMONT ELITE</p>	 <p>CATHEDRAL/ CATHEDRAL ELITE</p>	 <p>CARLTON/ CARLTON ELITE</p>	 <p>SALISBURY/ SALISBURY ELITE</p>	 <p>HORIZON/ HORIZON ELITE</p>	 <p>CHEVRON/ CHEVRON ELITE</p>	 <p>PARADE- WHITE/BROWN</p>
	Spring type	Spring type	Spring type	Spring type	Spring type	Spring type	Spring type	Spring type
6'6"x6'3"	-	-	-	N/A	-	N/A	-	-
6'6"x6'6"	4763	-	-	4776	-	4775	4775	-
6'6"x7'0"	4765	-	-	4777	-	4776	4765	-
7'0"x6'3"	-	-	-	N/A	-	N/A	-	-
7'0"x6'6"	4764	4763	4763	4776	4764	4775	4777	4763
7'0"x7'0"	4765	4764	4764	4763	4766	4777	4764	4764
7'3½"x6'4"	-	-	-	N/A	-	N/A	-	-
7'5"x6'3"	-	-	-	N/A	-	N/A	-	-
7'5"x6'6"	4764	4764	4764	4777	4768	4776	4776	4764
7'5"x7'0"	4766	4765	4765	4766	4766	4763	4763	4765
7'6"x6'6"	4766	4764	4764	4764	4766	4776	4766	4764
7'6"x7'0"	4768	4765	4765	4766	4766	4763	4768	4764
7'8½"x6'3"	-	-	-	N/A	-	N/A	-	-
7'8½"x6'6¾"	4768	4766	4766	4764	-	4763	4764	-
7'8½"x6'11¼"	4769	4768	4768	4764	-	4764	4766	-
8'0"x6'3"	-	-	-	N/A	-	N/A	-	-
8'0"x6'6"	4768	4766	4766	4764	4766	4763	-	4766
8'0"x7'0"	4769	4768	4768	4767	4768	4764	-	4768
8'2½"x6'3"	-	-	-	N/A	-	N/A	-	-
8'2½"x6'6¾"	-	-	-	-	-	-	-	4766
8'2½"x6'11¼"	-	-	-	-	-	-	-	4768
9'0"x6'6"	4775	-	-	4769	-	4769	-	-
9'0"x7'0"	4776	-	-	4769	-	4769	-	-
10'0"x6'6"	4776	-	-	4774	-	4769	-	-
10'0"x7'0"	4776	-	-	4775	-	4774	-	-
11'0"x6'6"	4777	-	-	4775	-	4774	-	-
11'0"x7'0"	4777	-	-	4776	-	4775	-	-
12'0"x6'6"	4763	-	-	4776	-	4775	-	-
12'0"x7'0"	4764	-	-	4777	-	4776	-	-
13'0"x6'6"	4768	-	-	4764	-	4777	-	-
13'0"x7'0"	4769	-	-	4766	-	4763	-	-
14'0"x6'6"	4769	-	-	4766	-	4764	-	4769
14'0"x7'0"	4770	-	-	4768	-	4766	-	4770
15'0"x6'6"	-	-	-	4768	-	4766	-	-
15'0"x7'0"	-	-	-	4769	-	4766	-	-
16'0"x6'6"	-	-	-	4769	-	4769	-	-
16'0"x7'0"	-	-	-	4770	-	4770	-	-

Last three digits identification stamped onto alloy tag and or spring eye.

R, FR & DR Type Spring

GRP Premier Panel Doors









Used on all FR and R type doors pre 2002

 £ 62.00 ea.	 STAMFORD	 ARDEN	 KENMORE	 DERWENT	 SWINTON	 CLIFTON	 OAKHAM	 WOBURN
	Spring type	Spring type	Spring type	Spring type	Spring type	Spring type	Spring type	Spring type
7'0"x6'6"	4766	4766	4766	4766	4766	4766	4766	4766
7'0"x7'0"	4766	4766	4766	4766	4766	4766	4766	4766
7'5"x6'6"	4766	4766	4766	4766	4766	4766	4766	4766
7'6"x7'0"	4766	4766	4766	4766	4766	4766	4766	4766
9'0"x6'6"	4769	4769	4769	-	-	4769	-	-
9'0"x7'0"	4769	4769	4769	-	-	4769	-	-
10'0"x6'6"	4769	4769	4769	-	-	4769	-	-
10'0"x7'0"	4769	4774	4774	-	-	4774	-	-
11'0"x6'6"	-	4774	4774	-	-	-	-	-
11'0"x7'0"	-	4775	4775	-	-	-	-	-
12'0"x6'6"	-	4776	4776	-	-	-	-	-
12'0"x7'0"	-	4776	4776	-	-	-	-	-
14'0"x6'6"	4763	4763	4763	-	-	4763	-	-

R, FR & DR Type Spring





Timber Panel Doors

Used on all FR and R type doors pre 2002

 £ 62.00 ea.	 CHEVRON CEDAR	 VERTICAL CEDAR	 SANDHURST	 CAVENDISH	 WOLSEY	 SEYMOUR	 TUDOR	 HORIZONTAL CEDAR
	Spring type	Spring type	Spring type	Spring type	Spring type	Spring type	Spring type	Spring type
7'0"x6'6"	4763	4775	-	-	4764	4764	4764	N/A
7'0"x7'0"	4764	4775	4766	4766	4764	4764	4764	N/A
7'5"x6'6"	4764	4776	4764	4764	4764	4764	4764	N/A
7'5"x7'0"	4766	4763	4766	4766	4766	4766	4766	N/A
7'6"x6'6"	4764	4763	4764	4764	4764	4764	4764	-
7'6"x7'0"	4764	4763	-	-	4766	4766	4766	-
14'0"x6'6"	-	4768	4766	4766	4763	4763	4763	-
14'0"x7'0"	-	4768	4768	4768	4764	4764	4764	-





<h2>Spring Cover Tubes</h2> 	
Article	R & DR Spring Cover Tubes (sold in pairs) Suitable for all R, FR and DR springs. Length 595 mm.
Part No.	1151
Price £	9.50 ea.

Used on all DC and DR type doors pre 2002 (685 mm long).

 <p>£ 52.00 ea.</p>	 GEORGIAN	 CARLTON	 HORIZON	 PARADE-WHITE/BROWN
	DC Spring	DC Spring	DC Spring	DC Spring
9'0"x6'6"	4755	4754	4752	-
9'0"x7'0"	4756	4754	4754	-
10'0"x6'6"	4756	4754	4752	-
10'0"x7'0"	4756	4756	4754	-
11'0"x6'6"	4756	4755	4754	-
11'0"x7'0"	4757	4757	4756	-
12'0"x6'6"	4758	4756	4755	-
12'0"x7'0"	4758	4758	4757	-
13'0"x6'6"	4750	4758	4757	-
13'0"x7'0"	4752	4749	4758	-
14'0"x6'6"	4751	4748	4758	4753
14'0"x7'0"	4753	4750	4749	4754
15'0"x6'6"	-	4749	4748	-
15'0"x7'0"	-	4752	4750	-
16'0"x6'6"	-	4751	4750	-
16'0"x7'0"	-	4753	4752	-







Double doors not sold as Elite.

Used on all DC and DR type doors pre 2002

 <p>£ 52.00 ea.</p>	 STAMFORD	 ARDEN	 KENMORE	 CLIFTON
	DC Spring	DC Spring	DC Spring	DC Spring
9'0"x6'6"	4750	4750	4750	4750
9'0"x7'0"	4753	4753	4753	4753
10'0"x6'6"	4753	4753	4753	4753
10'0"x7'0"	4755	4755	4755	4755
11'0"x6'6"	-	4754	4754	-
11'0"x7'0"	-	4756	4756	-
12'0"x6'6"	-	4755	4755	-
12'0"x7'0"	-	4757	4757	-
14'0"x6'6"	4757	4757	4757	4757

DC Type Spring



Used on all DC and DR type doors pre 2002

 <p>£ 52.00 ea.</p>	 VERTICAL CEDAR	 SANDHURST	 CAVENDISH	 WOLSEY	 SEYMOUR	 TUDOR
	DC Spring	DC Spring	DC Spring	DC Spring	DC Spring	DC Spring
14'0"x6'6"	4748	4751	4751	4748	4748	4748
14'0"x7'0"	4748	4750	4750	4749	4749	4749

<h2>Spring Cover Tubes</h2>	
Article	DC Spring Cover Tubes (sold in pairs) Suitable for all DC springs. Length 685 mm.
Part No.	1152
Price £	9.00 ea.

Cables, Rollers, Spindles

Cables				
Article	C type pre 1999 (overhead spring) 6'6" (1980 mm) wide door	C type pre 1999 (overhead spring) 7'0" (2135 mm) to 8'2½" (2500 mm) wide door	C type pre 1999 (overhead spring) Belgravia doors only (sold in pairs)	C type 1999-2002 (side extension spring) (Sold in pairs)
Part No.	1154	1155	1156	1157
Price £	24.00 / pair	24.00 / pair	24.00 / pair	24.00 / pair

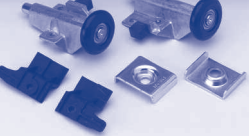
Cables			
Article	C type 2002 - current (Sold in pairs)	Canopy cable drum 2002 - current	Double door top roller and bracket 2002 - current
Part No.	45	(LH) 57, (RH) 58	1940
Price £	21.00 / pair	10.00 ea.	34.00 / set



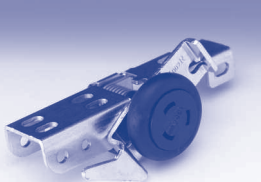
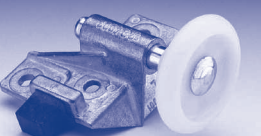
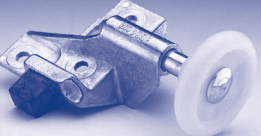

Rollers and spindles				
Article	Rollers & spindles (pair) Overall length 94 mm MK 3 C type only	Rollers & spindles (pair) Overall length 81 mm C type only	F type spindle (pair) E clip supplied	Roller spindle assembly (pair) Overall length 87 mm suitable for DC/DR/FR/R
Part No.	1158	1159	1160	304
Price £	31.00 / pair	31.00 / pair	24.50 / pair	32.00 / pair

Rollers and spindles				
Article	Roller & spindle assembly (pair) (Side extension spring)	Safety latch & roller (each LH & RH) For canopy doors 2002 - current	Roller bracket assembly For all framed retractable doors 2002 - 2003	Roller bracket assembly For all framed retractable doors 2003 - current
Part No.	1161	(LH) 127, (RH) 128	(LH) 123, (RH) 124	(LH) 120, (RH) 121
Price £	31.00 / pair	22.00 ea.	29.00 ea.	22.00 ea.

Keys, Locking Barrels

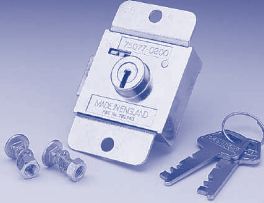
Keys			
Article	ZA series keys ¹	92 series keys ¹	CES blanks Suitable for current range ready for cutting
Part No.	1162	1163	2000
Price £	10.00 / pair	10.00 / pair	10.00 / pair

¹The serial No. is stamped on the lock, spindle or handle. Key series is either ZA0001 to ZA0200 or 92/201 to 92/400.
Not available for twin latch doors from December 1993.

Locks				
Article	Lock ZA series Includes keys, washers, nuts and bolts. Back face - ZA0001-ZA0200	Lock barrel (1992 - 1998) ² Length 40 mm Steel	Lock barrel (1992 - 1998) ² Length 50 mm T&G Timber	Lock barrel (1992 - 1998) ² Length 70 mm GRP/Elizabethan
Part No.	1164	1165	1166	1173
Price £	32.00 ea.	24.00 ea.	31.00 ea.	31.00 ea.

²Keys are not available separately.

Lock body c/w cylinders				
Article	Suitable for all Carlton, Horizon, Salisbury, Chevron & all double steel doors (30.5 + 10)	Suitable for all Georgian, Beaumont, Cathedral, Vertical Cedar and Cavendish doors (35+10)	Suitable for all Tudor, Seymour, Wolsey, Shaftsbury and single GRP doors (40+10)	Suitable for all Sandhurst, Chevron Cedar, Kingsbury, Barrington, Bosworth and all double GRP doors (55.5+10)
Part No.	204	202	203	2078
Price £	30.50 ea.	30.50 ea.	36.50 ea.	36.50 ea.

Handle Mechanisms

Handle mechanisms			
Article	Handle repair kit DR/DC type only up to Dec. 1993 (latch cable only)	Handle conversion kit Includes keys, washer, plastic cups, screws, counterplates, plastic crank, slit bolt & nut	T-handle assembly Includes keys, washer, slit bolt & nut, plastic cups and screws. Key no. between 201 & 400
Part No.	1170	1171	1191 (Black)
Price £	11.00 ea.	45.00 ea.	38.50 ea.



Handle mechanisms				
Article	Outside handle black Length 75 mm 1992 - 1998	Outside handle black Length 115 mm 1992 - 1998	Outside handle brass Length 75 mm 1992 - 1998	Outside handle brass Length 115 mm 1992 - 1998
Part No.	1178	1179	1180	1181
Price £	14.50 ea.	14.50 ea.	28.50 ea.	28.50 ea.

Handle mechanisms				
Article	Black handle - single door Black 1998 - April 2002	Brass handle - single door Brass 1998 - April 2002	Black handle - double door Black 1998 - April 2002	Brass handle - double door Brass 1998 - April 2002
Part No.	1182	1183	1184	1185
Price £	21.00 ea.	30.00 ea.	24.00 ea.	33.00 ea.

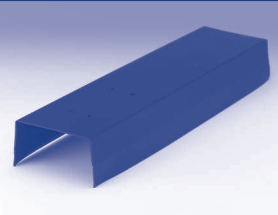
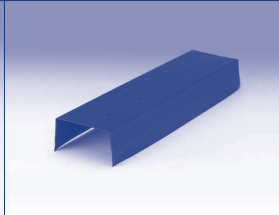

Handle mechanisms				
Article	Euro lock handle (complete) Black 75 mm July 1998 - April 2002	Euro lock handle (complete) Brass 75 mm July 1998 - April 2002	Euro lock handle (complete) Black 115 mm July 1998 - April 2002	Euro lock handle (complete) Brass 115 mm July 1998 - April 2002
Part No.	1186	1187	1188	1189
Price £	42.00 ea.	60.00 ea.	47.50 ea.	66.00 ea.

Handle Mechanisms, Weatherseals

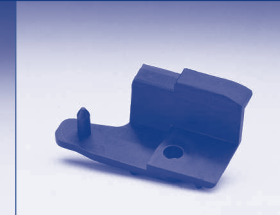
Handle mechanisms				
Article	Standard black handle All steel doors 2002 - current	Standard black handle (adjustable & fascia) All timber & GRP doors 2002 - current	Additional lock kit For canopy doors 2003 - current	Additional lock kit For retractable doors 2003 - current
Part No.	550	232	1768	1769
Price £	11.50 ea.	19.50 ea.	47.50 ea.	47.50 ea.

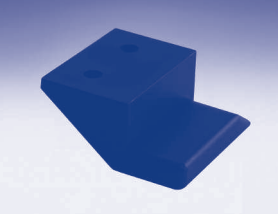
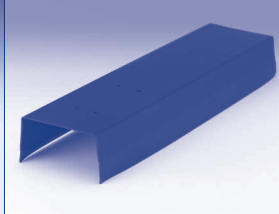

Cover profiles & Pivot blocks				
Article	Finger trap protection For retractable doors 2004 - current	Finger trap protection For retractable plus doors 2005 - current	Pivot block (frame) 2004 - current	Pivot block (panel) For retractable doors 2004 - current
Part No.	100	1844	(LH) 88, (RH) 89	(LH) 251, (RH) 252
Price £	10.50 ea.	10.50 ea.	10.00 ea.	11.50 ea.

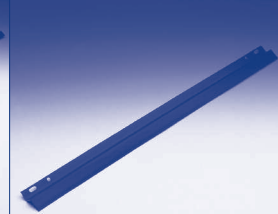
Cover profiles & Pivot blocks		
Article	Frame pivot block For N800 double doors	Finger guard For N800 double doors
Part No.	(LH) 4272, (RH) 4273	4285
Price £	10.00 ea.	10.00 ea.

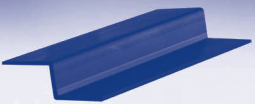

Weatherstrips			
Article	Canopy door top weatherstrip 2002 - current	Canopy door bottom weatherstrip 2002 - current (cut to length)	Retractable top weatherstrip Specify height of door when ordering
Part No.	110	111	104, 105
Price £	12.50 ea.	12.50 ea.	12.50 ea.

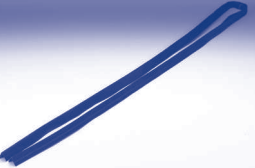
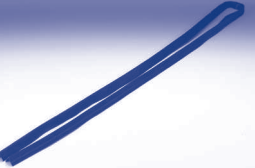
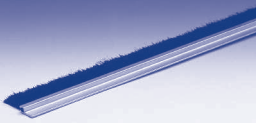
Weatherseals, Latches



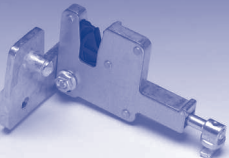
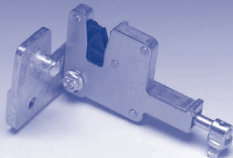

Weatherstrips		
Article	Mid frame weatherstrip 1980/2136 For N800 double doors	Bottom frame weatherstrip 1980/2136 For N800 double doors
Part No.	4314/4315	4310/4311
Price £	12.00 ea.	15.00 ea.

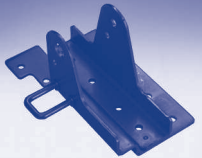
Weather seals				
Article	Bottom weather seal Length 2405 mm	Bottom weather seal Length 3000 mm	Brushstrip Approx. 2.5 m long	Glue down rubber weatherseal Approx. 2.5 m long
Part No.	1192	1193	1196	1837
Price £	26.00 ea.	30.00 ea.	27.00 ea.	29.00 ea.

Latches				
Article	Canopy door latch assembly 2002 - current	Canopy door latch keeper 2002 - current	Retractable latch For steel doors 2002 - 2003	Retractable latch For GRP doors 2002 - 2006
Part No.	122	126	(LH) 180, (RH) 181	(LH) 180, (RH) 181
Price £	9.00 ea.	8.50 ea.	24.00 ea.	24.00 ea.

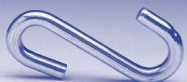

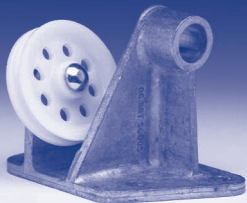

Latches				
Article	Retractable latch For steel doors 2005 - current	Retractable latch For timber doors 2005 - current & GRP doors (gold in colour) 2006 - current	N800 double door latch keeper For steel frames	N800 double door latch keeper For timber frames
Part No.	(LH) 2790, (RH) 2791	(LH) 3076, (RH) 3077	(LH) 4275, (RH) 4276	(LH) 4306, (RH) 4307
Price £	24.00 ea.	24.00 ea.	50.00 ea.	58.00 ea.

C & F Type Accessories

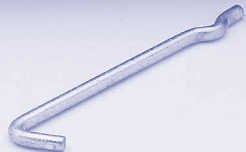
C Type				
Article	S-Hook 1999 - 2002	Link arm (bare) Supplied with clip 1999 - 2002	Wall bracket assembly 1999 - 2002	Spring anchor bracket 1999 - 2002
Part No.	1194	(LH) 1204, (RH) 1205	(LH) 1206, (RH) 1207	1208
Price £	7.50 ea.	24.00 ea.	18.50 ea.	9.00 ea.

C Type				
Article	Track & slider assembly 1999 - 2002	Side unit cover 1999 - 2002	C Type link arm	Link arm Supplied with pin spacer and washer Up to March 2002
Part No.	(LH) 1209, (RH) 1210	1195	(LH) 1202, (RH) 1203	(LH) 1199, (RH) 1200
Price £	18.50 ea.	18.50 ea.	37.00 ea.	37.00 ea.



F Type	
Article	Spring anchor top pin Up to March 2002
Part No.	1197
Price £	13.00 ea.

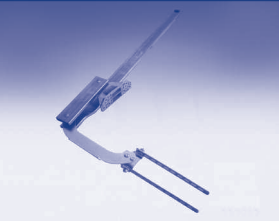
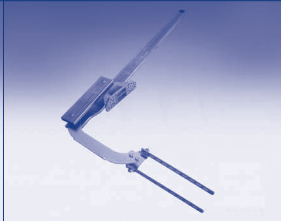
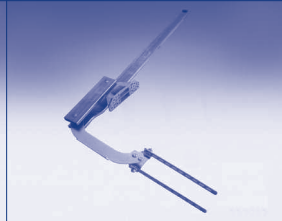

Retractable Single Sized Doors				
Article	Retractable link arm assembly For steel frame 6'6" 2002 - current	Retractable link arm assembly For steel frame 7'0" 2002 - current	Retractable link arm assembly For timber frame 6'6" 2002 - current	Retractable link arm assembly For timber frame 7'0" 2002 - current
Part No.	(LH) 61, (RH) 62	(LH) 63, (RH) 64	(LH) 4836, (RH) 4837	(LH) 4838, (RH) 4839
Price £	30.00 ea.	30.00 ea.	38.00 ea.	38.00 ea.

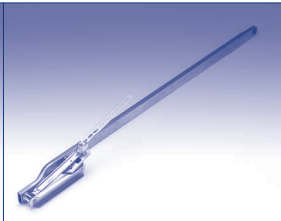
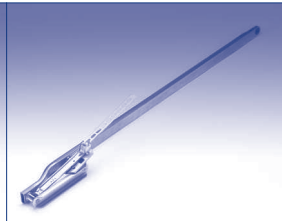
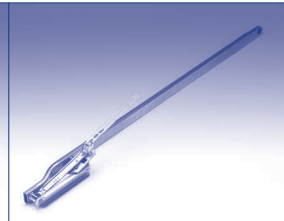
Link Arms

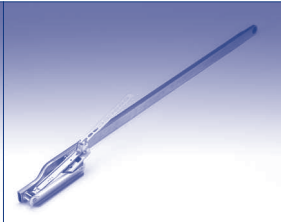
N800 Double Door Link arms			
Article	Link arm 1931 mm	Link arm 1980 mm	Link arm 2036 mm
Part No.	(LH) 6013, (RH) 6014	(LH) 4278, (RH) 4279	(LH) 4280, (RH) 4281
Price £	87.00 ea.	87.00 ea.	87.00 ea.

Double Door Link arm assembly				
Article	Link arm assembly For steel frame 6'4" Pre 2007	Link arm assembly For steel frame 6'6" Pre 2007	Link arm assembly For steel frame 7'0" Pre 2007	Link arm assembly For steel frame 7'6" Pre 2007
Part No.	(LH) 199400001, (RH) 199500001	(LH) 1917, (RH) 1918	(LH) 1919, (RH) 1920	(LH) 199400002, (RH) 199500002
Price £	60.00 ea.	60.00 ea.	60.00 ea.	60.00 ea.

Double Door Link arm assembly				
Article	Link arm assembly For timber frame 6'4" Pre 2007	Link arm assembly For timber frame 6'6" Pre 2007	Link arm assembly For timber frame 7'0" Pre 2007	Link arm assembly For timber frame 7'6" Pre 2007
Part No.	(LH) 197700008, (RH) 197800008	(LH) 197700001, (RH) 197800001	(LH) 197700002, (RH) 197800002	(LH) 197700003, (RH) 197800003
Price £	60.00 ea.	60.00 ea.	60.00 ea.	60.00 ea.

Canopy Link arm assembly		
Article	Canopy link arm assembly GRP	Canopy link arm assembly Steel/Timber After June 2003
Part No.	187	145
Price £	37.00 ea.	37.00 ea.

DR, R, FR & DC Type Accessories

DR, R, FR & DC Type				
Article	Roller bracket (on door) Suitable for DC/DR from 1988 to 2002	Link arm assembly Suitable for R/FR/DR from 1998 to 2002	Spring anchor pin E-Clip supplied (sold individually) Suitable for DC/DR/FR/R	Rubber stop DC type only from 1992
Part No.	344	295	1211	1213
Price £	8.50 ea.	94.50 ea.	12.00 ea.	12.00 ea.

DR, R, FR & DC Type				
Article	Spring anchor bracket from 1988 to 2002	Link arm assembly Up to & inc 7'0" high E-Clip supplied with both items Suitable for DC	Link arm assembly Over 7'0" high E-Clip supplied with both items Suitable for DC	Spring anchor pin Suitable for R/FR/DR from 1988 to 2002
Part No.	345	302	303	1214
Price £	11.50 ea.	94.50 ea.	94.50 ea.	10.00 ea.





Track assembly				
Article	DR track	DC track Up to 7'	DC track Over 7'	Canopy track assembly (Includes cable & roller) 2002 - current
Part No.	(LH) 301, (RH) 300	(LH) 299, (RH) 298	(LH) 297, (RH) 296	(LH) 160, (RH) 161
Price £	52.00 ea.	99.50 ea.	107.00 ea.	49.50 ea.

Track assembly			
Article	Retractable track assembly ¹ up to 10' wide - 6'4" high only 2002 - current	Retractable track assembly ¹ up to 10' wide - 6'6" high only 2002 - current	Retractable track assembly ¹ up to 10' wide - 7'0" high only 2002 - current
Part No.	(LH) 269, (RH) 270	(LH) 271, (RH) 272	(LH) 273, (RH) 274
Price £	35.50 ea.	35.50 ea.	35.50 ea.

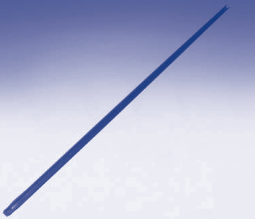
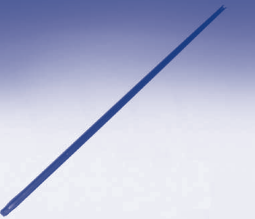
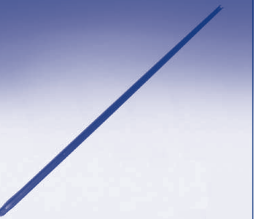
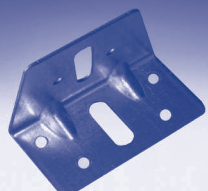
¹Please specify steel or timber framed option when ordering.

DR, R, FR & DC Type Accessories, Springs



Track assembly				
Article	N800 double door track 1931 mm L/R	N800 double door track 1980 mm L/R	N800 double door track 2139 mm L/R	Track/wall bracket For N800 double door
Part No.	6015	4372	4373	4284
Price £	52.00 ea.	52.00 ea.	52.00 ea.	12.00 ea.

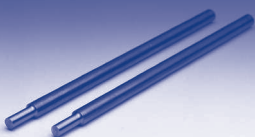

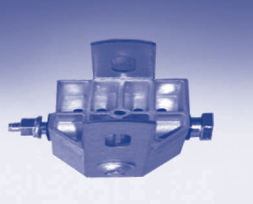

Track assembly				
Article	Double door track For steel frame 6'6" Pre 2007	Double door track For steel frame 7'0" Pre 2007	Double door track For timber frame 6'6" Pre 2007	Double door track For timber frame 7'0" Pre 2007
Part No.	(LH) 198300001, (RH) 198400001	(LH) 198300002, (RH) 198400002	(LH) 197500001, (RH) 197600001	(LH) 197500002, (RH) 197600002
Price £	48.50 ea.	48.50 ea.	48.50 ea.	48.50 ea.

Springs canopy doors		
Article	Canopy spring assembly (State door size when ordering) 2002 - current	Canopy tensioning bars
Part No.	1223	1222
Price £	76.00 ea.	14.50 set of two

Spring coupling bracket	
Article	Spring coupling bracket For N800 double doors
Part No.	4379
Price £	28.00 ea.

Springs

Springs retractable & retractable plus doors			
Article	Retractable spring assembly 001 2002 - current	Retractable spring assembly 002 2002 - current	Retractable spring assembly 003 2002 - current
Part No.	52	53	54
Price £	75.50 / pair	75.50 / pair	75.50 / pair

Springs double doors				
Article	Double door spring assembly 615 2004 - current	Double door spring assembly 621 2004 - current	Double door spring assembly 4er 025 2004 - current	Double door spring assembly 4er 032 2004 - current
Part No.	1943	1944	1946	1945
Price £	96.00 / pair	96.00 / pair	96.00 / pair	96.00 / pair

Springs double doors				
Article	Double door spring assembly 612 2004 - current	Double door spring assembly 623 2004 - current	Tensioning tool For all single retractable doors 2002 - current	Tensioning tool For double retractable doors 2008 - current
Part No.	2004	2005	1907	1909
Price £	96.00 / pair	96.00 / pair	69.00	69.00

Spares for current range of electric operators

Delatching kits & Emergency releases				
Article	Delatching kit For all single & double retractable doors	Emergency release For retractable doors with lock and handle	Emergency release For sectional doors with lock and handle	Emergency release Canopy doors or sectional doors without handles
Part No.	2643	704	702	703
Price £	42.00 ea.	34.00 ea.	42.00 ea.	42.00 ea.

Canopy bow arms				
Article	Bow arm For canopy doors	Reinforcing kit For sectional doors	Extended towing arm 258 mm long	Extended towing arm 495 mm long
Part No.	708	712	2482	2628
Price £	75.00 ea.	45.00 ea.	14.00 ea.	31.00 ea.

Radio receiver & transmitters				
Article	HS4 Grey buttons 40 mHz	HSM4 Grey buttons 40 mHz	HSE2 Grey buttons 40 mHz	Radio Receiver Grey button 40 mHz
Part No.	674	676	677	685
Price £	52.00 ea.	52.00 ea.	52.00 ea.	73.00 ea.

Receiver			
Article	Receiver IP65 40 mHz	Receiver IP65 868 mHz	Key ring
Part No.	687	692	4877
Price £	167.50 ea.	167.50 ea.	1.00 ea.

Radio Receivers, Transmitters, Autodor Spares

Radio receiver & transmitters				
Article	HS4 Blue buttons 868 mHz	HSM4 Blue buttons 868 mHz	HSE2 Blue buttons 868 mHz	Radio receiver Blue button 868 mHz
Part No.	680	682	683	690
Price £	52.00 ea.	52.00 ea.	52.00 ea.	73.00 ea.

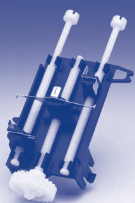
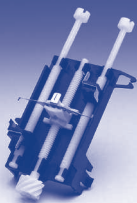

Autodor spares				
Article	Autodor Elite printed circuit board 27 mHz	Autodor Elite printed circuit board 418 mHz	Autodor printed circuit board 27 mHz	Autodor printed circuit board 418 mHz
Part No.	1229	1230	1231	1232
Price £	162.00 ea.	162.00 ea.	162.00 ea.	162.00 ea.

Autodor spares			
Article	Printed circuit board 433 mHz	Autodor Elite limit assembly	Autodor limit assembly
Part No.	1233	1234	1235
Price £	162.00 ea.	24.00 ea.	26.50 ea.

Autodor spares				
Article	3 Channel key fob 433 mHz	Autodor Elite trolley rack	Single channel handset 433 mHz	Single channel handset 27 mHz
Part No.	1238	1239	1240	1241
Price £	59.50 ea.	31.00 ea.	54.00 ea.	54.00 ea.

Consumables

Bulbs			
Article	Bulb Suitable for M2 and Expert	Bulb Suitable for GaraMatic 10 & 20 operators	Bulb Suitable for GaraMatic 7 & 9 operators Auto Expert
Part No.	2641	4643	715
Price £	6.50 ea.	9.00 ea.	6.00 ea.

Batteries			
Article	Battery Suitable for HS2/HSM2, HS4 and HSM4	Battery Suitable for HSE2	Battery Suitable for wall consoles etc.
Part No.	2522	2521	4644
Price £	8.00 ea.	8.00 ea.	7.50 ea.

Door Stays	
Article	Side-hung door stays
Part No.	2449
Price £	56.00 / pair

A Garador garage door needs only a minimum level of preparation and maintenance to give years of trouble-free service. Below is a guide to how to get the best from your garage door.

Operation

- For opening the door in manual operation use only the outside handle or inside handle. Never use the pull rope during the opening cycle of the door.
- For closing the door from the outside – the pull rope fixed to the internal handle is only designed to pull the door towards you whilst standing within the entrance of the garage until the door can be pushed down by hand, then using the external handle for final closing.
- For closing the door from the inside – the pull rope already mentioned is designed to be pulled away from you, when facing the front entrance of the garage, until the internal handle is able to be reached, by hand, and used for final closing. The pull rope is not designed to be used for any other part of the operating cycle, or any other purpose. Failure to comply with the above instructions may result in injury to persons or property.
- When the door is operated from either outside or inside, check the area through which the door will travel is clear from people and objects. Failure to do so may result in injury to persons or property.
- When closing, ensure the latches engage properly.
- If the door is power-operated always try to ensure you match the door with a Garador electric operator to ensure full compliance with the Machinery Directive. If another make must be used always consider any compatibility/compliance issues.

Cleaning

- The door, and frame if applicable, should be washed with a mild soap-based solution on a regular basis to prevent the build up of dirt, salts and other corrosive substances and help maintain the aesthetic appearance of the product.
- If the door is installed in a seafront location, the door panel and frame should be cleaned in this way at least every two months.
- We also suggest that all other components be brushed down on a regular basis to prevent the build up of dirt and dust etc.

Locking

- If the key is turned completely, the door is then locked or unlocked; when unlocked it is then possible to open and close the door by turning the handle.
- If the key is turned 1/4 of the way, the door opened and then the key returned to its start position, the door will re-lock when closed.
- By moving the internal locking "snib", it is possible to lock and unlock the door from the inside without using the key.

Maintenance

- If in doubt about any of these maintenance procedures below always consult a Garador specialist. Garador Ltd. has a nationwide network of installers who will be able to offer you a regular maintenance service on your garage door. Please call Garador or refer to the Garador website for further details of your nearest installer.
- Immediately after the door is fitted and after every 5,000 operations of the door, or at least once a year, oil all pivot points, check screws and clamped connections for tightness, keep the running tracks clean (do not grease them), check parts and replace any worn components where necessary.
- The springs should be replaced after approx. 25,000 operations by an experienced door fitter (see fitting and operation instructions).
- Do not oil the lock cylinder; if it is sticking, only lubricate with graphite dust.
- For canopy doors only, check the cable every 6 months with normal usage (8 operations per day). Have the cables replaced by an expert if any wear is found.

Finish – Steel Doors

The coating process applied to the door and chassis is environmentally friendly. Minor scratches or marks are not covered under the conditions of our warranty and should be repaired immediately to prevent corrosion and deterioration of the panel. Corrosive such as acids, alkalines, and salts, etc. should be cleaned from the door immediately; failure to do so will result in deterioration of the finish, which will not be covered under our warranty. If you choose to paint your powder coated door then prepare the surface lightly with wet and dry. Then treat with two coats of a normal commercial paint for external use (cellulose paints must not be used).

Finish – Timber Doors

Timber doors are supplied poly-wrapped, and the timber panels coated with a neutralising base-stain (except Cavendish, which is supplied untreated). Doors must be stored upright, under cover, with wrapping intact, until wrapping is removed. As soon as the door is unwrapped, one coat of a good quality basecoat primer must be applied to both sides of the door. Immediately after installation, your timber doors require a further two coats of a good quality exterior wood finish on both sides. Initial application and periodic treatment should be carried out strictly in accordance with the woodstain manufacturer's instructions. Failure to follow these instructions will result in early deterioration of the timber panel.

Finish – GRP Doors

GRP door panels should periodically washed down using water. This should be done more frequently if fitted near the sea. Bird droppings will bleach the finish on GRP, and should be removed using water as soon as possible. GRP doors should not be painted over.

Paint Finish – Steel Doors

Garador steel doors are a finished product. They do not require re-painting on site. They are however not immune to damage, which can occur at any stage of the handling of the product from factory to site. Minor surface damage can easily be repaired using touch up sprays or sticks without invalidating warranties. For extra peace of mind, order your steel door poly-wrapped at the factory to help prevent damage from occurring prior to installation.

Garador products are manufactured to the highest quality standards and leave our factory only after rigorous quality testing. However, if you should have grounds for complaint, this section tells you what our door warranty offers, and how to go about making your claim.

In the unlikely event of a warranty claim becoming necessary, please contact the dealer or distributor who originally supplied your garage door. Your dealer should then supply details of the claim, together with a copy of the warranty card provided with the door and proof of purchase to the Warranty Department at Garador Ltd.

To enable your claim under warranty to be processed as quickly as possible, you should provide the following details:

- 1 Your name, address and telephone number
- 2 Original invoice with date of purchase
- 3 Product description/door type and product number
- 4 Description of defect

An assessment of the claim will then be made. This may require Garador to inspect the product in-situ. In the event that there is no legitimate warranty claim under the terms specified herein, you may be liable for the costs of the inspection visit. We strongly recommend that you take note of the care and usage instructions displayed on the stickers on the back of your garage door, and on the page opposite, and that you follow these instructions throughout.

Garador installers Garador Ltd. has a nationwide network of recommended installers who will be able to offer you a regular maintenance service on your garage door. Please call us on 0800 706670 or refer to the Garador website for further details of your nearest installer.

Garador Garage Door Warranty

- Warranty Period** The purchaser is granted a warranty covering the safe and reliable function of the Garador garage door for a period of 10 years from the date of purchase. A 5 year warranty applies to springs, wire cables, track rollers, hinges and guide rollers. The warranty period for replacement parts is 6 months or to the end of the current warranty period, whichever is longer. In the case of foil-coated timber-effect and PVC doors, a warranty of 5 years is granted, for timber and GRP doors a warranty of 2 years is granted on the door panels alone under the terms and conditions specified herein. The door mechanism and steel frame (if applicable) is covered by the 10 year warranty period.
- Requirements** Warranty claims are only applicable in the country where the garage door was purchased. The product must have been purchased through our authorised distribution channels. The warranty only covers damage to the contract object. The fully completed warranty card together with the receipt of purchase correspondingly dated substantiates your right to claim under the warranty.
- Performance** During the warranty period we undertake to rectify any and all defects to the Garador product which can be proved to be attributed to a material or manufacturing fault. We pledge at our discretion either to exchange the defective merchandise for faultless merchandise, repair it or allow a reduction in price. We do not accept costs for dismantling and installation nor for carriage. Replaced parts become our property. The warranty does not cover damage caused through:
- normal wear and tear
 - improper installation
 - negligent care and maintenance
 - improper initial and subsequent operation
 - negligent or wanton destruction
 - external influences such as fire, water, salts, alkaline solutions, acids, abnormal environmental influences
 - mechanical damage through improper transport and fitting
 - priming and other surface protection treatments
 - incorrect or too late applied surface protection treatments
 - repair by non-qualified persons
 - using non-Garador parts without the approval of the manufacturer
 - remove of the product number or making it unidentifiable
- Electric Operator Warranty** A separate 5 year warranty is granted on our electric operators. This includes operator mechanics, motor and motor control systems. A 2 year warranty is granted on radio equipment, accessories and system controls. There is no warranty on consumables (e. g. fuses, batteries, bulbs etc.). For further details please contact us on 0800 706670, or through our website on www.garador.co.uk

The following document was designed by the Association of Garage Door Specialists, updated by the DHF and endorsed by all major UK garage door manufacturers, as a guide for purchasers of domestic garage doors.

VISUAL APPEARANCE OF GARAGE DOORS

A new garage door can be a significant investment that will transform the appearance of your home. This information is a guide to the quality you can expect.

THE QUALITY CHECK

The quality check should be carried out in natural daylight, not direct sunlight. Stand at a distance of 3 metres from the door to view the overall appearance.

The door is acceptable if, taking into account the facts below, none of the following are readily visible on the face of the door:

- Marks or distortion associated with the manufacturing process
- Minor indentations, marks or scuffs on the surface
- Paint or stain blemishes

THE FACTS

STEEL DOORS

Panel Distortion The rolling or pressing of steel panels during manufacture will cause distortion in the steel and while every effort is made to keep this to a minimum, inevitably some visible distortion will remain. The application of high gloss paints will make this slight distortion more apparent, especially under certain lighting conditions, such as car headlamps, or bright sunshine.

Paint Finish Primed doors – the primer coating is applied as a base coat only and as such requires additional finishing with a good quality exterior paint. Any marks or scratches on the primer coat should be rubbed down and repainted as part of this finishing process.

Finished doors – the factory application of the paint finish is an automated process and this may result in minor blemishes or slight inconsistencies in the paint, particularly in the area of panel joints.

TIMBER DOORS

Timber Timber is a natural product and there will be variations in pattern, colour, shading and grains. No two doors will be the same. Because wood naturally expands and contracts according to environmental conditions, joints will open and close and some minor curvature may occur.

Finishing It is vital that timber doors are fully finished as per the manufacturers instructions before exposure to the elements.

GRP AND COMPOSITE PLASTIC DOORS

Mould Marks GRP doors are individually handcrafted in a mould and are then hand finished. Some minor marks and blemishes will inevitably remain after this process.

Translucency When viewed from the inside, it is often possible to see variations in the translucency of the door, particularly around and between areas of relief. Such variations do not detract from the overall strength or build quality of the door.

ALL DOORS

Colour Match Pairs of doors should be ordered together to obtain the best colour match, bearing in mind the limitations of the materials used in the construction. Timber garage doors cannot be ordered as matching sets.

Size Variations As the size of a door changes in height and/or width, the panel frequency and profile can change, therefore doors of the same style but of different sizes can be significantly different in appearance.

Clearances All doors require operating clearances, i.e. the gap between the door panel and the frame opening, these are inbuilt during manufacture and should not be reduced by means of infills, or draughtproofing.

Deflection When in the open position, all doors will display a level of vertical deflection or 'sag' across the width of the panel. Individual manufacturers' specifications should be consulted for exact tolerances.

Since the company's policy is one of continuous improvement of its products, we reserve the right to make any alterations in design, manufacture or price. All business is governed by the company's Standard Conditions and this document does not form any part of any contract with the company and statements contained in it should not be construed as representations or warranties.

GARADOR

Bunford Lane, Yeovil, Somerset, BA20 2EJ
Tel: (01935) 443722 Fax: (01935) 443744

www.garador.co.uk

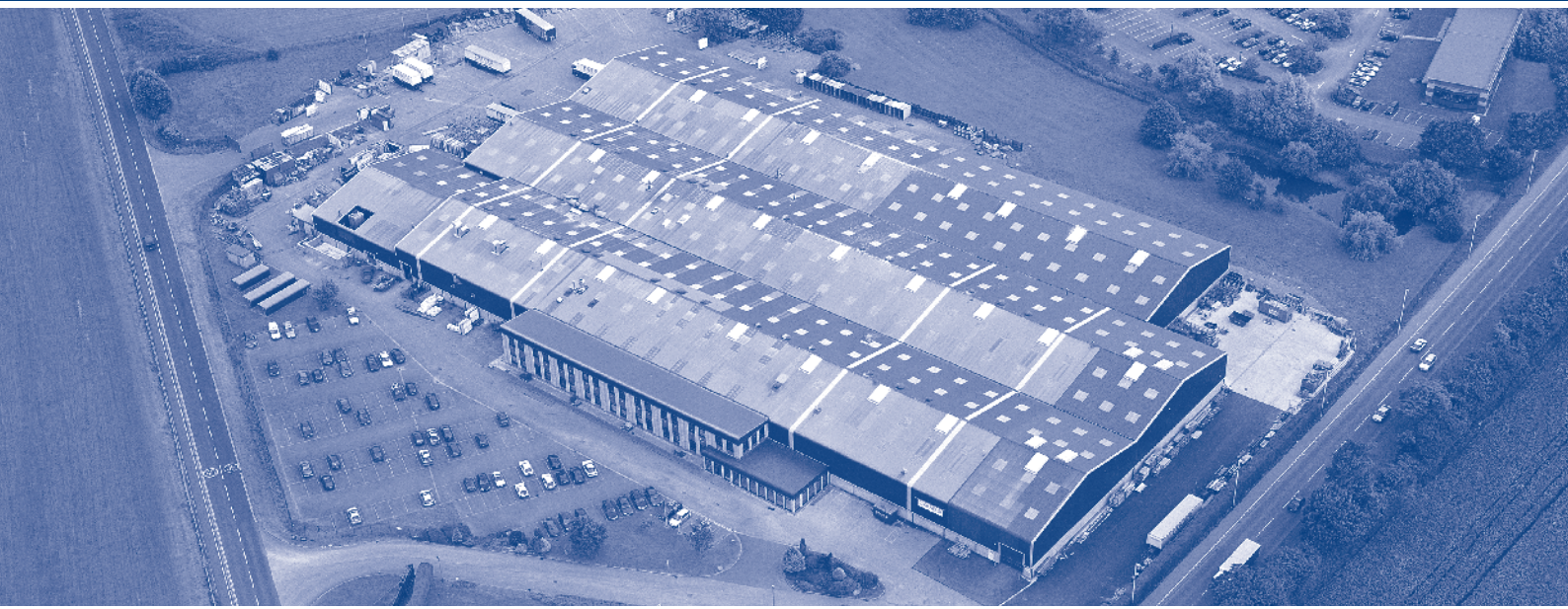

Garador Limited, with German engineering and manufactured in the UK producing the most sophisticated doors and operators. Manufactured at our modern production facility located in Somerset we are proud to provide the highest level of quality, safety, security and service.